

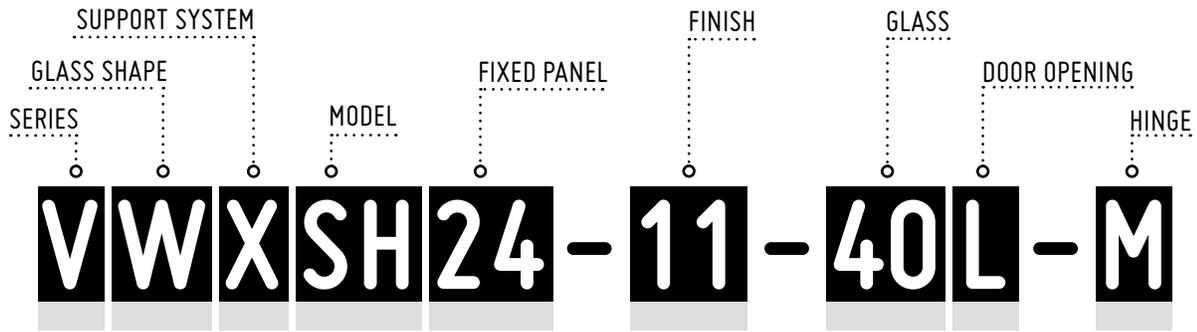

EVOLUTION

MONACO SERIES



4', 5' AND 6' SERIES

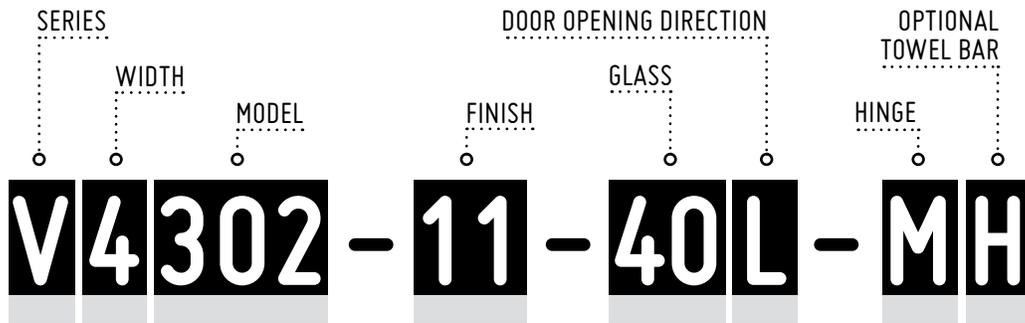

SERIES — V EVOLUTION		
<p>MONACO SERIES SUPPORT SYSTEMS</p> <p>X SUPPORT BAR SYSTEM</p> <p>G GLASS SHELF SUPPORT*</p> <p><small>*Rectangular "M" and Square "T" Hinges come with SQUARE Glass Shelf Support BRACKETS.</small></p> <p><small>*Oval "Q" and Round "R" Hinges come with ROUND Glass Shelf Support BRACKETS.</small></p>	<p>WIDTH</p> <p>4 4' WIDE MODELS</p> <p>56 5' & 6' WIDE MODELS</p> <p>6 6' WIDE MODELS</p>	<p>DOOR OPENING DIRECTION</p> <p>R RIGHT OPENING</p> <p>L LEFT OPENING</p>
<p>MONACO SERIES MODELS</p> <p>SH TUB SHIELD</p> <p>SS SHOWER SHIELD</p>	<p>METAL FINISHES</p> <p>11 BRIGHT CHROME</p> <p>25 BRUSHED NICKEL</p> <p>29 OIL-RUBBED BRONZE</p>	<p>HINGES</p> <p>M RECTANGULAR</p> <p>Q OVAL</p> <p>T SQUARE</p> <p>R ROUND</p>
<p>MONACO SERIES FIXED PANEL</p> <p>FIXED PANEL WIDTH</p>	<p>GLASS</p> <p>40 CLEAR GLASS</p> <p>80 MIST GLASS</p>	<p>TOWEL BAR</p> <p>H FLAT TOWEL BAR</p> <p>Y ROUND TOWEL BAR</p>

11 Bright Chrome



25 Brushed Nickel



29 Oil-Rubbed Bronze



MODEL NUMBER EXPLANATIONS 2
EXAMPLE OF CODE SYSTEM 4
PRODUCT OPTIONS 5
FEATURES 6 - 7



MONACO SQUARE TOP TUB SHIELD WITH FIXED PANEL 8 - 9



MONACO ROUND TOP TUB SHIELD WITH FIXED PANEL 10 - 11



SOLO TUB SHIELD 12 - 13



MONACO SQUARE TOP SHOWER SHIELD WITH FIXED PANEL 14 - 15



MONACO ROUND TOP SHOWER SHIELD WITH FIXED PANEL 16 - 17



4' AND 5' WALK-IN SHOWER SYSTEM 18 - 19

5' AND 6' WALK-IN SHOWER SYSTEM 20 - 25

6' WALK-IN SHOWER SYSTEM 26 - 31



ECLIPSE CURVED GLASS WALK-IN SHOWER SYSTEM 32

MICROTEK – GLASS SURFACE PROTECTION 33 - 34

MONACO SERIES



GLASS SHELF SUPPORT - "G"

SUPPORT BAR SYSTEM - "X"

SELECT YOUR DOOR OPENING DIRECTION AND HINGE STYLE



*FOR MODELS WITH GLASS SHELF SUPPORT - "G"
Rectangular and Square Hinges come with Square Glass Shelf Brackets.
Oval and Round Hinges come with Round Glass Shelf Brackets.
**Available in 3/8" (10-mm) Clear Glass only.*

VWGSH24-11-40**L**-**M**

- EVOLUTION
- SQUARE TOP SHIELD
- GLASS SHELF SUPPORT
- TUB SHIELD
- 24" FIXED PANEL
- BRIGHT CHROME FINISH
- CLEAR GLASS
- LEFT OPENING DIRECTION
- RECTANGULAR HINGES

4', 5' and 6' SERIES



SELECT YOUR DOOR OPENING DIRECTION, HINGE STYLE AND OPTIONAL TOWEL BAR

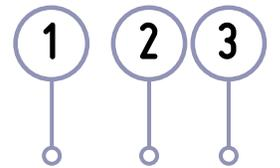

V4302-11-40**L**-**T****H**

- EVOLUTION
- WIDTH - 4 FEET
- MODEL
- BRIGHT CHROME FINISH
- CLEAR GLASS
- LEFT OPENING DIRECTION
- SQUARE HINGES
- OPTIONAL FLAT TOWEL BAR (NOT SHOWN)

**1 IDENTIFY OPENING DIRECTION
THIS IS MANDATORY**

VWXSS24-11-40**L**-T

OPENING DIRECTION

FOR MODELS WITHOUT HINGES

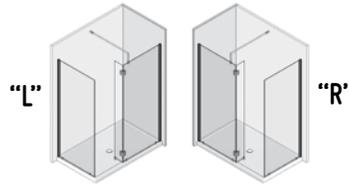

"L" (LEFT) or "R" (RIGHT) indicates the entry location as viewed from the exterior.

FOR MODELS WITH HINGES

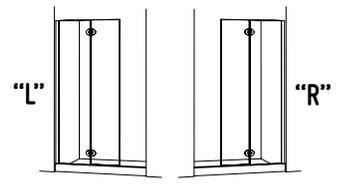

"L" (LEFT) or "R" (RIGHT) indicates where the hinges are installed on the shield panel as viewed from the exterior.

**2 SELECT SOLID BRASS HINGE STYLE
THIS IS MANDATORY**

V4302-11-40**L**-**T**H

HINGE STYLE

M Rectangular



Q Oval



T Square



R Round



**3 SELECT UV BONDED TOWEL BAR
[SURCHARGE APPLIES]**

AVAILABLE FOR CERTAIN MODELS ONLY. INSTALLATION POSITION VARIES FOR EACH MODEL. SEE INDIVIDUAL MODEL PAGES FOR POSITION.



V4302-25-40**L**-**Q****H**

OPTIONAL FLAT TOWEL BAR

Available in two finishes:
Chrome - Surcharge \$ 225
Brushed - Surcharge \$ 209



V4302-11-40**L**-**Q****Y**

OPTIONAL ROUND TOWEL BAR

DRAIN NO-CALK™ SHOWER BASE DRAIN*		DRAINABS-11	ABS No-Calk 2" drain	\$29	Chrome
		DRAINABS-25	ABS No-Calk 2" drain	\$39	Brushed Nickel
		DRAINPVC-11	PVC No-Calk 2" drain	\$29	Chrome
		DRAINPVC-25	PVC No-Calk 2" drain	\$39	Brushed Nickel

*Please check local codes to ensure appropriate drain specifications

FEATURES

EUROPEAN STYLE FRAMELESS DOORS

TEMPERED GLASS THICKNESS:
3/8" (10 mm) OR 1/4" (6 mm)
5/16" (8 mm) FOR CURVED
GLASS PANELS

GLASS AVAILABLE IN CLEAR AND MIST*
**MIST AVAILABLE FOR CERTAIN MODELS ONLY*

75" HIGH GLASS PANELS FOR
SHOWER MODELS

OPTIONAL MICROTEK
GLASS SURFACE PROTECTION

MULTIPLE CONFIGURATIONS

CUSTOM SIZES AVAILABLE

10-YEAR LIMITED WARRANTY

EUROPEAN STYLE
SUPPORT BARS

PVC SEAL FOR
WATER RETENTION

4 HINGE SHAPES
3 FINISHES

ADJUSTABLE WALL JAMBS

OPTIONAL
TOWEL BAR

DEFLECTOR SHIELD
TECHNOLOGY

MONACO

SQUARE TOP TUB SHIELD WITH FIXED PANEL



SQUARE TOP TUB SHIELD WITH FIXED PANEL

Available with your choice of two support systems

MONACO SUPPORT BAR SYSTEM

58" H (59 1/2" to top of support bar)

3/8" (10 mm) Clear Tempered Glass

SUPPORT BAR SYSTEM			
MODEL	PRICE	FINISH	GLASS
VWXSH24-11-40①-②	\$1,260	Bright Chrome	CLEAR
VWXSH24-25-40 _ _	\$1,401	Brushed Nickel	CLEAR
VWXSH24-29-40 _ _	\$1,496	Oil-Rubbed Bronze	CLEAR

Support Bar System

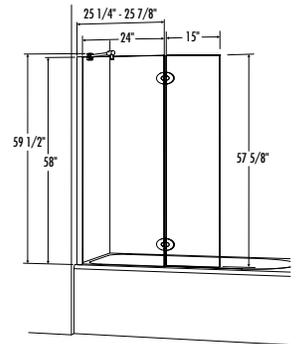

SUPPORT BAR SYSTEM - "X"

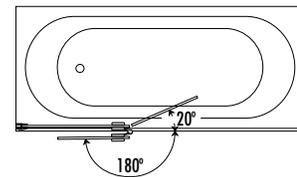

MONACO GLASS SHELF SUPPORT

58" H

3/8" (10 mm) Clear Tempered Glass

GLASS SHELF SUPPORT			
MODEL	PRICE	FINISH	GLASS
VWGSH24-11-40①-②	\$1,260	Bright Chrome	CLEAR
VWGSH24-25-40 _ _	\$1,401	Brushed Nickel	CLEAR
VWGSH24-29-40 _ _	\$1,496	Oil-Rubbed Bronze	CLEAR

Glass Shelf Support

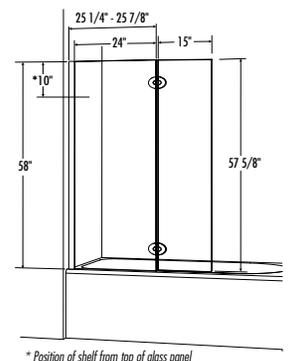

* Position of shelf from top of glass panel

SELECT OPTIONS

Insert Code L or R

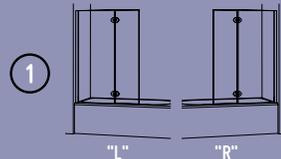

Insert Code M, Q, T or R

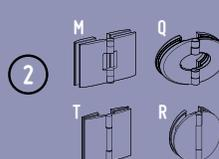

MONACO

ROUND TOP TUB SHIELD WITH FIXED PANEL



ROUND TOP TUB SHIELD WITH FIXED PANEL

Available with your choice of two support systems

MONACO SUPPORT BAR SYSTEM

58" H (59 1/2" to top of support bar)

3/8" (10 mm) Tempered Glass			
SUPPORT BAR SYSTEM			
MODEL	PRICE	FINISH	GLASS
CLEAR TEMPERED GLASS 3/8" (10 mm)			
VXSH24-11-40①-②	\$1,260	Bright Chrome	CLEAR
VXSH24-25-40 _ _	\$1,401	Brushed Nickel	CLEAR
VXSH24-29-40 _ _	\$1,496	Oil-Rubbed Bronze	CLEAR
MIST TEMPERED GLASS 3/8" (10 mm)			
VXSH24-11-80①-②	\$1,410	Bright Chrome	MIST
VXSH24-25-80 _ _	\$1,551	Brushed Nickel	MIST
VXSH24-29-80 _ _	\$1,646	Oil-Rubbed Bronze	MIST

MONACO GLASS SHELF SUPPORT

58" H

*GLASS SHELF SUPPORT			
MODEL	PRICE	FINISH	GLASS
CLEAR TEMPERED GLASS 3/8" (10 mm)			
VGSH24-11-40①-②	\$1,260	Bright Chrome	CLEAR
VGSH24-25-40 _ _	\$1,401	Brushed Nickel	CLEAR
VGSH24-29-40 _ _	\$1,496	Oil-Rubbed Bronze	CLEAR
MIST TEMPERED GLASS 3/8" (10 mm)			
VGSH24-11-80 _ _	\$1,410	Bright Chrome	MIST
VGSH24-25-80①-②	\$1,551	Brushed Nickel	MIST
VGSH24-29-80 _ _	\$1,646	Oil-Rubbed Bronze	MIST

*Glass Shelves are available in 3/8" (10 mm) Clear Glass only.

MONACO SUPPORT BAR SYSTEM

1/4" (6 mm) Tempered Glass			
SUPPORT BAR SYSTEM			
MODEL	PRICE	FINISH	GLASS
CLEAR TEMPERED GLASS 1/4" (6 mm)			
VSH24-11-40①-②	\$907	Bright Chrome	CLEAR
VSH24-25-40 _ _	\$1,048	Brushed Nickel	CLEAR
VSH24-29-40 _ _	\$1,143	Oil-Rubbed Bronze	CLEAR
<i>The above models are only available with the support bar system</i>			
MIST TEMPERED GLASS 1/4" (6 mm)			
VSH24-11-80①-②	\$1,159	Bright Chrome	MIST
VSH24-25-80 _ _	\$1,300	Brushed Nickel	MIST
VSH24-29-80 _ _	\$1,396	Oil-Rubbed Bronze	MIST
<i>The above models are only available with the support bar system</i>			

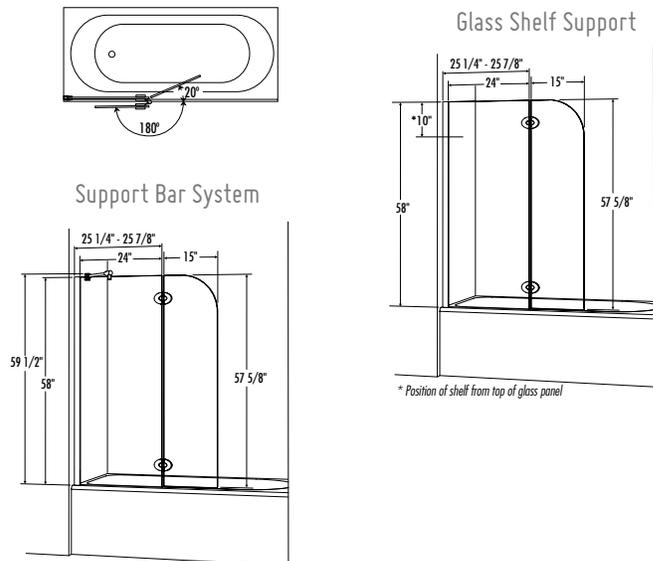

SUPPORT BAR SYSTEM - "X"



SELECT OPTIONS

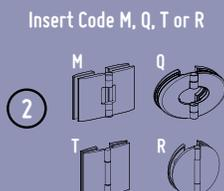
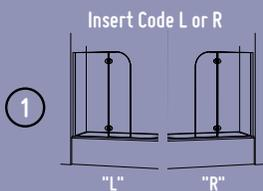

SOLO TUB SHIELD



SOLO 29" W x 63" H

3/8" (10 mm) CLEAR TEMPERED GLASS

MODEL	PRICE	FINISH	GLASS
VXT029-11-40 ①-②	\$856	Bright Chrome	CLEAR
VXT029-25-40 _ _	\$920	Brushed Nickel	CLEAR
VXT029-29-40 _ _	\$1,002	Oil-Rubbed Bronze	CLEAR

1/4" (6 mm) CLEAR TEMPERED GLASS

MODEL	PRICE	FINISH	GLASS
VT029-11-40 ①-②	\$699	Bright Chrome	CLEAR
VT029-25-40 _ _	\$763	Brushed Nickel	CLEAR
VT029-29-40 _ _	\$845	Oil-Rubbed Bronze	CLEAR

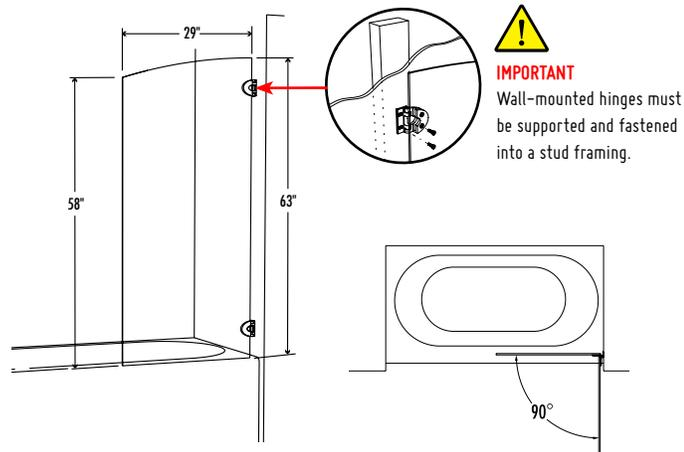

SELECT OPTIONS

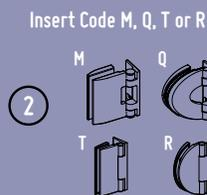
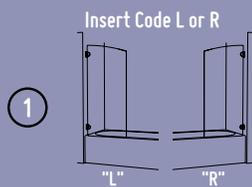

MONACO

SQUARE TOP SHOWER SHIELD WITH FIXED PANEL



SQUARE TOP SHOWER SHIELD WITH FIXED PANEL

Available with your choice of two support systems

MONACO SUPPORT BAR SYSTEM

75" H (76 1/2" to top of support bar)

3/8" (10 mm) Clear Tempered Glass

SUPPORT BAR SYSTEM			
MODEL	PRICE	FINISH	GLASS
VWXSS24-11-40 ①-②	\$1,333	Bright Chrome	CLEAR
VWXSS24-25-40 _ _	\$1,451	Brushed Nickel	CLEAR
VWXSS24-29-40 _ _	\$1,568	Oil-Rubbed Bronze	CLEAR

*BASE	PRICE	COLOR	SIZE
ABF3642-18K	\$690	White	42" x 36" x 2 3/4"
ABF3642-13K	\$725	Biscuit	42" x 36" x 2 3/4"
ABF3448-18K	\$669	White	48" x 34" x 2 3/4"
ABF3448-13K	\$705	Biscuit	48" x 34" x 2 3/4"
ABF3648-18K	\$708	White	48" x 36" x 2 3/4"
ABF3648-13K	\$745	Biscuit	48" x 36" x 2 3/4"
ABF3260-18K	\$788	White	60" x 32" x 3"
ABF3260-13K	\$827	Biscuit	60" x 32" x 3"
ABF3460-18K	\$815	White	60" x 34" x 2 3/4"
ABF3460-13K	\$855	Biscuit	60" x 34" x 2 3/4"
ABF3660-18K	\$843	White	60" x 36" x 2 3/4"
ABF3660-13K	\$885	Biscuit	60" x 36" x 2 3/4"
ABF4260-18K	\$885	White	60" x 42" x 2 3/4"
ABF4260-13K	\$929	Biscuit	60" x 42" x 2 3/4"
ABF4860-18K	\$981	White	60" x 48" x 2 3/4"
ABF4860-13K	\$1,030	Biscuit	60" x 48" x 2 3/4"

MONACO GLASS SHELF SUPPORT

75" H

3/8" (10 mm) Clear Tempered Glass

GLASS SHELF SUPPORT			
MODEL	PRICE	FINISH	GLASS
VWGSS24-11-40 ①-②	\$1,333	Bright Chrome	CLEAR
VWGSS24-25-40 _ _	\$1,451	Brushed Nickel	CLEAR
VWGSS24-29-40 _ _	\$1,568	Oil-Rubbed Bronze	CLEAR

*BASE	PRICE	COLOR	SIZE
ABF3642-18K	\$690	White	42" x 36" x 2 3/4"
ABF3642-13K	\$725	Biscuit	42" x 36" x 2 3/4"
ABF3448-18K	\$669	White	48" x 34" x 2 3/4"
ABF3448-13K	\$705	Biscuit	48" x 34" x 2 3/4"
ABF3648-18K	\$708	White	48" x 36" x 2 3/4"
ABF3648-13K	\$745	Biscuit	48" x 36" x 2 3/4"
ABF3260-18K	\$788	White	60" x 32" x 3"
ABF3260-13K	\$827	Biscuit	60" x 32" x 3"
ABF3460-18K	\$815	White	60" x 34" x 2 3/4"
ABF3460-13K	\$855	Biscuit	60" x 34" x 2 3/4"
ABF3660-18K	\$843	White	60" x 36" x 2 3/4"
ABF3660-13K	\$885	Biscuit	60" x 36" x 2 3/4"
ABF4260-18K	\$885	White	60" x 42" x 2 3/4"
ABF4260-13K	\$929	Biscuit	60" x 42" x 2 3/4"
ABF4860-18K	\$981	White	60" x 48" x 2 3/4"
ABF4860-13K	\$1,030	Biscuit	60" x 48" x 2 3/4"



ABF3260
Side Drain Acrylic Base



ABF
Acrylic Base

SUPPORT BAR SYSTEM - "X"

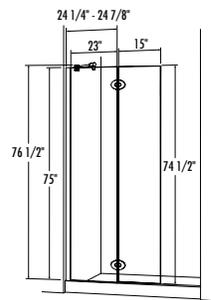

Support Bar System

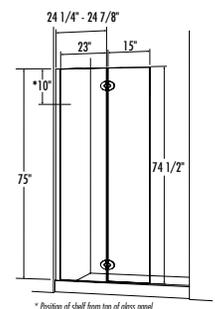

Glass Shelf Support

DRAIN

NO-CALK™
SHOWER BASE DRAIN*



DRAINABS-11	ABS No-Calk 2" drain	\$29	Chrome
DRAINABS-25	ABS No-Calk 2" drain	\$39	Brushed Nickel
DRAINPVC-11	PVC No-Calk 2" drain	\$29	Chrome
DRAINPVC-25	PVC No-Calk 2" drain	\$39	Brushed Nickel

*Please check local codes to ensure appropriate drain specifications

SELECT OPTIONS

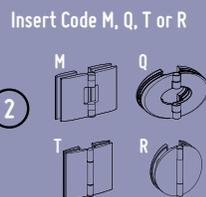
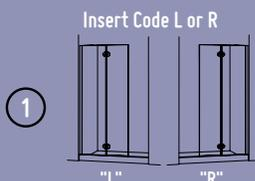

*SEE BASE SECTION FOR ADDITIONAL COMPATIBLE SHOWER MODELS AND TECHNICAL SPECIFICATIONS

MONACO

ROUND TOP SHOWER SHIELD WITH FIXED PANEL



ROUND TOP SHOWER SHIELD WITH FIXED PANEL

Available with your choice of two support systems

MONACO SUPPORT BAR SYSTEM

75" H (76 1/2" to top of support bar)

SUPPORT BAR SYSTEM			
MODEL	PRICE	FINISH	GLASS
CLEAR TEMPERED GLASS 3/8" (10 mm)			
VXSS24-11-40 ^{①-②}	\$1,333	Bright Chrome	CLEAR
VXSS24-25-40 _ _	\$1,451	Brushed Nickel	CLEAR
VXSS24-29-40 _ _	\$1,568	Oil-Rubbed Bronze	CLEAR
MIST TEMPERED GLASS 3/8" (10 mm)			
VXSS24-11-80 ^{①-②}	\$1,455	Bright Chrome	MIST
VXSS24-25-80 _ _	\$1,574	Brushed Nickel	MIST
VXSS24-29-80 _ _	\$1,691	Oil-Rubbed Bronze	MIST

*BASE	PRICE	COLOR	SIZE
ABF3642-18K	\$690	White	42" x 36" x 2 3/4"
ABF3642-13K	\$725	Biscuit	42" x 36" x 2 3/4"
ABF3448-18K	\$669	White	48" x 34" x 2 3/4"
ABF3448-13K	\$705	Biscuit	48" x 34" x 2 3/4"
ABF3648-18K	\$708	White	48" x 36" x 2 3/4"
ABF3648-13K	\$745	Biscuit	48" x 36" x 2 3/4"
ABF3260-18K	\$788	White	60" x 32" x 3"
ABF3260-13K	\$827	Biscuit	60" x 32" x 3"
ABF3460-18K	\$815	White	60" x 34" x 2 3/4"
ABF3460-13K	\$855	Biscuit	60" x 34" x 2 3/4"
ABF3660-18K	\$843	White	60" x 36" x 2 3/4"
ABF3660-13K	\$885	Biscuit	60" x 36" x 2 3/4"
ABF4260-18K	\$885	White	60" x 42" x 2 3/4"
ABF4260-13K	\$929	Biscuit	60" x 42" x 2 3/4"
ABF4860-18K	\$981	White	60" x 48" x 2 3/4"
ABF4860-13K	\$1,030	Biscuit	60" x 48" x 2 3/4"



ABF3260

Side Drain Acrylic Base



ABF

Acrylic Base

SUPPORT BAR SYSTEM - "X"



MONACO GLASS SHELF SUPPORT

75" H

*GLASS SHELF SUPPORT			
MODEL	PRICE	FINISH	GLASS
CLEAR TEMPERED GLASS 3/8" (10 mm)			
VGSS24-11-40 ^{①-②}	\$1,333	Bright Chrome	CLEAR
VGSS24-25-40 _ _	\$1,451	Brushed Nickel	CLEAR
VGSS24-29-40 _ _	\$1,568	Oil-Rubbed Bronze	CLEAR
MIST TEMPERED GLASS 3/8" (10 mm)			
VGSS24-11-80 ^{①-②}	\$1,455	Bright Chrome	MIST
VGSS24-25-80 _ _	\$1,574	Brushed Nickel	MIST
VGSS24-29-80 _ _	\$1,691	Oil-Rubbed Bronze	MIST

**Glass Shelves are available in 3/8" (10 mm) Clear Glass only.*

*BASE	PRICE	COLOR	SIZE
ABF3642-18K	\$690	White	42" x 36" x 2 3/4"
ABF3642-13K	\$725	Biscuit	42" x 36" x 2 3/4"
ABF3448-18K	\$669	White	48" x 34" x 2 3/4"
ABF3448-13K	\$705	Biscuit	48" x 34" x 2 3/4"
ABF3648-18K	\$708	White	48" x 36" x 2 3/4"
ABF3648-13K	\$745	Biscuit	48" x 36" x 2 3/4"
ABF3260-18K	\$788	White	60" x 32" x 3"
ABF3260-13K	\$827	Biscuit	60" x 32" x 3"
ABF3460-18K	\$815	White	60" x 34" x 2 3/4"
ABF3460-13K	\$855	Biscuit	60" x 34" x 2 3/4"
ABF3660-18K	\$843	White	60" x 36" x 2 3/4"
ABF3660-13K	\$885	Biscuit	60" x 36" x 2 3/4"
ABF4260-18K	\$885	White	60" x 42" x 2 3/4"
ABF4260-13K	\$929	Biscuit	60" x 42" x 2 3/4"
ABF4860-18K	\$981	White	60" x 48" x 2 3/4"
ABF4860-13K	\$1,030	Biscuit	60" x 48" x 2 3/4"

Support Bar System

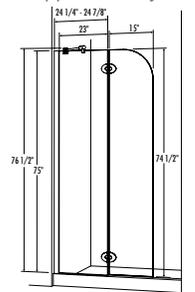

Glass Shelf Support

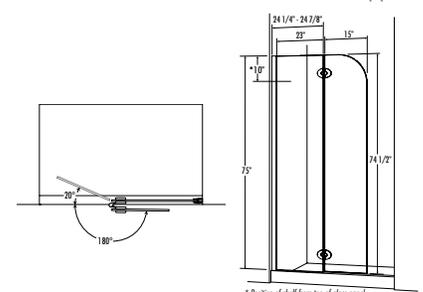

* Position of shelf from top of glass panel

SELECT OPTIONS

Insert Code L or R

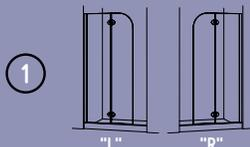

Insert Code M, Q, T or R

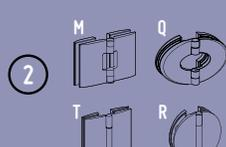

DRAIN
NO-CALK™
SHOWER BASE DRAIN*
SEE PAGE 5

Microtek
by Fleurco
Glass surface protection.
See information sheet at the end of this section for ordering details.

4' AND 5' WALK-IN SHOWER SYSTEM



4' AND 5' WALK-IN SHOWER SYSTEM

3/8" (10 mm) Clear Tempered Glass • 75" H (82 3/16" to top of support bar)

ROUND TOP	SQUARE TOP	DIMENSIONS	ROUND MODEL	SQUARE MODEL	PRICE	FINISH	GLASS
			V4301-11-40 ①-②	VW4301-11-40 ①-②	\$1,221	Bright Chrome	CLEAR
			V4301-25-40 _ _	VW4301-25-40 _ _	\$1,336	Brushed Nickel	CLEAR
			V4301-29-40 _ _	VW4301-29-40 _ _	\$1,439	Oil-Rubbed Bronze	CLEAR
			V4302-11-40 ①-②③	VW4302-11-40 ①-②③	\$1,643	Bright Chrome	CLEAR
			V4302-25-40 _ _ _	VW4302-25-40 _ _ _	\$1,758	Brushed Nickel	CLEAR
			V4302-29-40 _ _ _	VW4302-29-40 _ _ _	\$1,860	Oil-Rubbed Bronze	CLEAR

Shown with optional Towel Bar

*BASE	PRICE	COLOR	SIZE
ABF3648-18K	\$708	White	48" x 36" x 2 3/4"
ABF3648-13K	\$745	Biscuit	48" x 36" x 2 3/4"
ABF3260-18K	\$788	White	60" x 32" x 3"
ABF3260-13K	\$827	Biscuit	60" x 32" x 3"
ABF3660-18K	\$843	White	60" x 36" x 2 3/4"
ABF3660-13K	\$885	Biscuit	60" x 36" x 2 3/4"

Above base is compatible with models V4031 and VW4301

ABF3260
Side Drain Acrylic Base



ABF
Acrylic Base



ROUND TOP	SQUARE TOP	DIMENSIONS	ROUND MODEL	SQUARE MODEL	PRICE	FINISH	GLASS
			V4304-11-40 ①-②③	VW4304-11-40 ①-②③	\$1,786	Bright Chrome	CLEAR
			V4304-25-40 _ _	VW4304-25-40 _ _	\$1,914	Brushed Nickel	CLEAR
			V4304-29-40 _ _	VW4304-29-40 _ _	\$2,003	Oil-Rubbed Bronze	CLEAR

*BASE	PRICE	COLOR	SIZE
ABF3648-18K	\$708	White	48" x 36" x 2 3/4"
ABF3648-13K	\$745	Biscuit	48" x 36" x 2 3/4"
ABF3660-18K	\$843	White	60" x 36" x 2 3/4"
ABF3660-13K	\$885	Biscuit	60" x 36" x 2 3/4"

DRAIN	NO-CALK™ SHOWER BASE DRAIN*	Model	Material	Price	Finish
		DRAINABS-11	ABS No-Calk 2" drain	\$29	Chrome
		DRAINABS-25	ABS No-Calk 2" drain	\$39	Brushed Nickel
		DRAINPVC-11	PVC No-Calk 2" drain	\$29	Chrome
		DRAINPVC-25	PVC No-Calk 2" drain	\$39	Brushed Nickel

*Please check local codes to ensure appropriate drain specifications

• ADDITIONAL RETURN PANEL SIZES ARE AVAILABLE. CONTACT CUSTOMER SERVICE FOR DETAILS.

*GLASS SHELF SUPPORT

- RECTANGULAR AND SQUARE HINGES COME WITH SQUARE BRACKETS.
- OVAL AND ROUND HINGES COME WITH ROUND BRACKETS.

GLASS SHELF WITH ROUND BRACKET

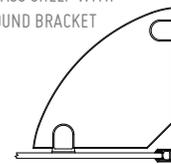

GLASS SHELF WITH SQUARE BRACKET

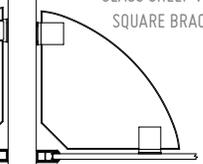

SELECT OPTIONS

*SEE BASE SECTION FOR ADDITIONAL COMPATIBLE SHOWER MODELS AND TECHNICAL SPECIFICATIONS

Insert Code L or R

1

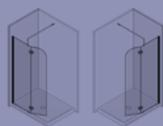

0414

"L"

"R"

Insert Code M, Q, T or R

2

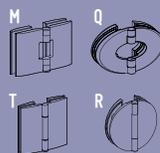

Insert Code H (flat) or Y (round) to select OPTIONAL TOWEL BAR

3

Towel Bar installs onto a Return Panel

Available in two finishes:
CHROME - Surcharge \$225
BRUSHED - Surcharge \$209

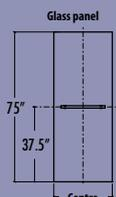

www.designashower.com

5' AND 6' WALK-IN SHOWER SYSTEM



5' AND 6' WALK-IN SHOWER SYSTEM

3/8" (10 mm) Clear Tempered Glass • 75" H (82 3/16" to top of support bar)

ROUND TOP	SQUARE TOP	DIMENSIONS	ROUND MODEL	SQUARE MODEL	PRICE	FINISH	GLASS
			V56304-11-40①-②③	VW56304-11-40①-②③	\$1,872	Bright Chrome	CLEAR
			V56304-25-40 _ _ _	VW56304-25-40 _ _ _	\$2,010	Brushed Nickel	CLEAR
			V56304-29-40 _ _ _	VW56304-29-40 _ _ _	\$2,160	Oil-Rubbed Bronze	CLEAR
			V56305-11-40①-②③	VW56305-11-40①-②③	\$2,364	Bright Chrome	CLEAR
			V56305-25-40 _ _ _	VW56305-25-40 _ _ _	\$2,513	Brushed Nickel	CLEAR
			V56305-29-40 _ _ _	VW56305-29-40 _ _ _	\$2,698	Oil-Rubbed Bronze	CLEAR

Shown with optional Towel Bar

*BASE	PRICE	COLOR	SIZE
ABF3660-18K	\$843	White	60" x 36" x 2 3/4"
ABF3660-13K	\$885	Biscuit	60" x 36" x 2 3/4"
ABF3672-18K	\$931	White	72" x 36" x 2 3/4"
ABF3672-13K	\$978	Biscuit	72" x 36" x 2 3/4"

ABF
Acrylic Base



ROUND TOP	SQUARE TOP	DIMENSIONS	ROUND MODEL	SQUARE MODEL	PRICE	FINISH	GLASS
			V56301-11-40①-②	VW56301-11-40①-②	\$1,255	Bright Chrome	CLEAR
			V56301-25-40 _ _ _	VW56301-25-40 _ _ _	\$1,359	Brushed Nickel	CLEAR
			V56301-29-40 _ _ _	VW56301-29-40 _ _ _	\$1,464	Oil-Rubbed Bronze	CLEAR
			V56302-11-40①-②③	VW56302-11-40①-②③	\$1,707	Bright Chrome	CLEAR
			V56302-25-40 _ _ _	VW56302-25-40 _ _ _	\$1,810	Brushed Nickel	CLEAR
			V56302-29-40 _ _ _	VW56302-29-40 _ _ _	\$1,950	Oil-Rubbed Bronze	CLEAR

Shown with optional Towel Bar

*BASE	PRICE	COLOR	SIZE
ABF3260-18K	\$788	White	60" x 32" x 3"
ABF3260-13K	\$827	Biscuit	60" x 32" x 3"
ABF3660-18K	\$843	White	60" x 36" x 2 3/4"
ABF3660-13K	\$885	Biscuit	60" x 36" x 2 3/4"
ABF3672-18K	\$931	White	72" x 36" x 2 3/4"
ABF3672-13K	\$978	Biscuit	72" x 36" x 2 3/4"

ABF3260
Side Drain
Acrylic Base



CONTINUED ON NEXT PAGE

- ADDITIONAL RETURN PANEL SIZES ARE AVAILABLE.
- CONTACT CUSTOMER SERVICE FOR DETAILS.

Above base is compatible with models V4031 and VW4301

DRAIN	NO-CALK™ SHOWER BASE DRAIN*	MODEL	DESCRIPTION	PRICE	FINISH
		DRAINABS-11	ABS No-Calk 2" drain	\$29	Chrome
		DRAINABS-25	ABS No-Calk 2" drain	\$39	Brushed Nickel
		DRAINPVC-11	PVC No-Calk 2" drain	\$29	Chrome
		DRAINPVC-25	PVC No-Calk 2" drain	\$39	Brushed Nickel

*Please check local codes to ensure appropriate drain specifications

SELECT OPTIONS

*SEE BASE SECTION FOR ADDITIONAL COMPATIBLE SHOWER MODELS AND TECHNICAL SPECIFICATIONS

1 Insert Code L or R

0414 "L" "R"

2 Insert Code M, Q, T or R

3 Insert Code H (flat) or Y (round) to select OPTIONAL TOWEL BAR

Towel Bar installs onto a panel

Available in two finishes:
CHROME - Surcharge \$225
BRUSHED - Surcharge \$209

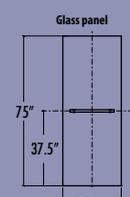

5' AND 6' WALK-IN SHOWER SYSTEM



5' AND 6' WALK-IN SHOWER SYSTEM (CONT'D)

3/8" (10 mm) Clear Tempered Glass • 75" H (82 3/16" to top of support bar)

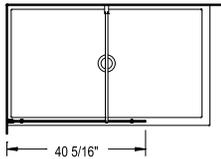
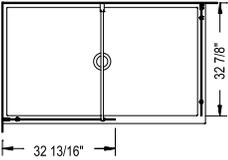
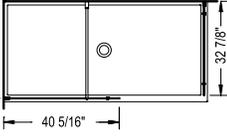
DIMENSIONS		MODEL	PRICE	FINISH	GLASS	
		V56310-11-40 ^{①-③}	\$790	Bright Chrome	CLEAR	
		V56310-25-40 _ _	\$835	Brushed Nickel	CLEAR	
		V56310-29-40 _ _	\$926	Oil-Rubbed Bronze	CLEAR	
			V56312-11-40 ^{①-③}	\$1,239	Bright Chrome	CLEAR
<i>Shown with optional Towel Bar</i>		V56312-25-40 _ _	\$1,285	Brushed Nickel	CLEAR	
		V56312-29-40 _ _	\$1,382	Oil-Rubbed Bronze	CLEAR	
			V6310-11-40 ^{①-③}	\$1,291	Bright Chrome	CLEAR
<i>Shown with optional Towel Bar</i>		V6310-25-40 _ _	\$1,336	Brushed Nickel	CLEAR	
		V6310-29-40 _ _	\$1,428	Oil-Rubbed Bronze	CLEAR	

*BASE	PRICE	COLOR	SIZE
ABF3648-18K	\$708	White	48" x 36" x 2 3/4"
ABF3648-13K	\$745	Biscuit	48" x 36" x 2 3/4"
ABF3260-18K	\$788	White	60" x 32" x 3"
ABF3260-13K	\$827	Biscuit	60" x 32" x 3"
<i>Above bases are compatible with model V56310 only</i>			
ABF3660-18K	\$843	White	60" x 36" x 2 3/4"
ABF3660-13K	\$885	Biscuit	60" x 36" x 2 3/4"
<i>Above base is compatible with models V56310 and V56312</i>			
ABF3672-18K	\$931	White	72" x 36" x 2 3/4"
ABF3672-13K	\$978	Biscuit	72" x 36" x 2 3/4"

CONTINUED ON NEXT PAGE

ABF3260

Side Drain
Acrylic Base



ABF

Acrylic Base



DRAIN

NO-CALK™
SHOWER BASE DRAIN*



DRAINABS-11
DRAINABS-25
DRAINPVC-11
DRAINPVC-25

ABS No-Calk 2" drain
ABS No-Calk 2" drain
PVC No-Calk 2" drain
PVC No-Calk 2" drain

\$29
\$39
\$29
\$39

Chrome
Brushed Nickel
Chrome
Brushed Nickel

- ADDITIONAL RETURN PANEL SIZES ARE AVAILABLE.
- CONTACT CUSTOMER SERVICE FOR DETAILS.

*Please check local codes to ensure appropriate drain specifications

SELECT OPTIONS

Insert Code L or R

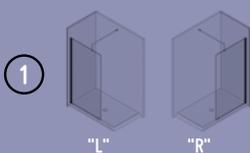

Insert Code H (flat) or Y (round)
to select OPTIONAL TOWEL BAR

3

Towel Bar installs
onto a panel

Available in two finishes:
CHROME - Surcharge \$215
BRUSHED - Surcharge \$200

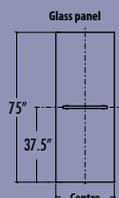

*SEE BASE SECTION FOR ADDITIONAL COMPATIBLE SHOWER MODELS AND TECHNICAL SPECIFICATIONS



5' AND 6' WALK-IN SHOWER SYSTEM



5' AND 6' WALK-IN SHOWER SYSTEM (CONT'D)

3/8" (10 mm) Clear Tempered Glass • 75" H (82 3/16" to top of support bar)

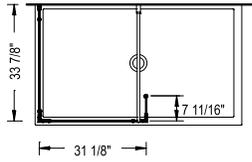
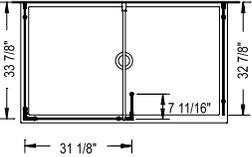
DIMENSIONS		MODEL	PRICE	FINISH	GLASS
 		V56307-11-40 ①-③	\$1,717	Bright Chrome	CLEAR
		V56307-25-40 _ _	\$1,844	Brushed Nickel	CLEAR
		V56307-29-40 _ _	\$1,983	Oil-Rubbed Bronze	CLEAR
 		V56308-11-40 ①-③	\$2,180	Bright Chrome	CLEAR
		V56308-25-40 _ _	\$2,307	Brushed Nickel	CLEAR
		V56308-29-40 _ _	\$2,484	Oil-Rubbed Bronze	CLEAR

*BASE	PRICE	COLOR	SIZE
ABF3660-18K	\$843	White	60" x 36" x 2 3/4"
ABF3660-13K	\$885	Biscuit	60" x 36" x 2 3/4"
ABF3672-18K	\$931	White	72" x 36" x 2 3/4"
ABF3672-13K	\$978	Biscuit	72" x 36" x 2 3/4"

ABF
Acrylic Base

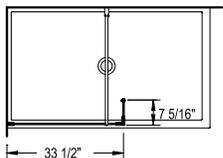
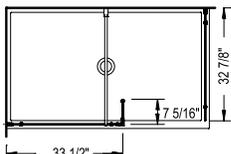

DIMENSIONS		MODEL	PRICE	FINISH	GLASS
 		V56314-11-40 ①-③	\$1,137	Bright Chrome	CLEAR
		V56314-25-40 _ _	\$1,218	Brushed Nickel	CLEAR
		V56314-29-40 _ _	\$1,311	Oil-Rubbed Bronze	CLEAR
 		V56315-11-40 ①-③	\$1,590	Bright Chrome	CLEAR
		V56315-25-40 _ _	\$1,670	Brushed Nickel	CLEAR
		V56315-29-40 _ _	\$1,786	Oil-Rubbed Bronze	CLEAR

*BASE	PRICE	COLOR	SIZE
ABF3648-18K	\$708	White	48" x 36" x 2 3/4"
ABF3648-13K	\$745	Biscuit	48" x 36" x 2 3/4"
ABF3260-18K	\$788	White	60" x 32" x 3"
ABF3260-13K	\$827	Biscuit	60" x 32" x 3"
<i>Above bases are compatible with model V56310 only</i>			
ABF3660-18K	\$843	White	60" x 36" x 2 3/4"
ABF3660-13K	\$885	Biscuit	60" x 36" x 2 3/4"
ABF3672-18K	\$931	White	72" x 36" x 2 3/4"
ABF3672-13K	\$978	Biscuit	72" x 36" x 2 3/4"

ABF3260

Side Drain
Acrylic Base



ABF
Acrylic Base



- ADDITIONAL RETURN PANEL SIZES ARE AVAILABLE.
- CONTACT CUSTOMER SERVICE FOR DETAILS.

SELECT OPTIONS

Insert Code L or R

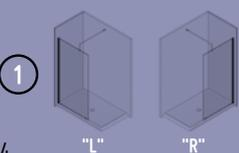

0414

Insert Code H (flat) or Y (round) to select OPTIONAL TOWEL BAR

③ Towel Bar installs onto a panel
Available in two finishes:
CHROME - Surcharge \$225
BRUSHED - Surcharge \$209

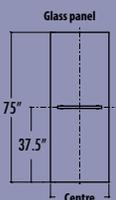

*SEE BASE SECTION FOR ADDITIONAL COMPATIBLE SHOWER MODELS AND TECHNICAL SPECIFICATIONS

DRAIN

NO-CALK™
SHOWER BASE DRAIN*

SEE PAGE 5



6' WALK-IN SHOWER SYSTEM



6' WALK-IN SHOWER SYSTEM (CONT'D)

3/8" (10 mm) Clear Tempered Glass • 75" H (82 3/16" to top of support bar)

DIMENSIONS		MODEL	PRICE	FINISH	GLASS
		V6302-11-40 ①-③	\$1,994	Bright Chrome	CLEAR
		V6302-25-40 _ _	\$2,156	Brushed Nickel	CLEAR
		V6302-29-40 _ _	\$2,307	Oil-Rubbed Bronze	CLEAR
		V6301-11-40 ①-③	\$1,573	Bright Chrome	CLEAR
		V6301-25-40 _ _	\$1,734	Brushed Nickel	CLEAR
		V6301-29-40 _ _	\$1,863	Oil-Rubbed Bronze	CLEAR
		V6303-11-40 ①-③	\$2,491	Bright Chrome	CLEAR
		V6303-25-40 _ _	\$2,652	Brushed Nickel	CLEAR
		V6303-29-40 _ _	\$2,849	Oil-Rubbed Bronze	CLEAR

*BASE	PRICE	COLOR	SIZE
ABF3672-18K	\$931	White	72" x 36" x 2 3/4"
ABF3672-13K	\$978	Biscuit	72" x 36" x 2 3/4"

ABF
Acrylic Base



CONTINUED ON NEXT PAGE

DRAIN NO-CALK™ SHOWER BASE DRAIN*		DRAINABS-11	ABS No-Calk 2" drain	\$29	Chrome
		DRAINABS-25	ABS No-Calk 2" drain	\$39	Brushed Nickel
	DRAINPVC-11	PVC No-Calk 2" drain	\$29	Chrome	
	DRAINPVC-25	PVC No-Calk 2" drain	\$39	Brushed Nickel	

*Please check local codes to ensure appropriate drain specifications

- ADDITIONAL RETURN PANEL SIZES ARE AVAILABLE.
- CONTACT CUSTOMER SERVICE FOR DETAILS.

SELECT OPTIONS

*SEE BASE SECTION FOR ADDITIONAL COMPATIBLE SHOWER MODELS AND TECHNICAL SPECIFICATIONS

Insert Code L or R

①



0414

"L"

"R"

Insert Code H (flat) or Y (round) to select OPTIONAL TOWEL BAR

③

Towel Bar installs onto a Return Panel

Available in two finishes:
CHROME - Surcharge \$225
BRUSHED - Surcharge \$209

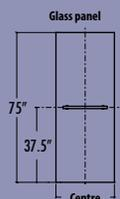

6' WALK-IN SHOWER SYSTEM



6' WALK-IN SHOWER SYSTEM (CONT'D)

3/8" (10 mm) Clear Tempered Glass • 75" H (82 3/16" to top of support bar)

ROUND TOP	SQUARE TOP	DIMENSIONS	ROUND MODEL	SQUARE MODEL	PRICE	FINISH	GLASS
			V6305-11-40 ①-②	VW6305-11-40 ①-②	\$1,874	Bright Chrome	CLEAR
			V6305-25-40 _ _	VW6305-25-40 _ _	\$2,071	Brushed Nickel	CLEAR
			V6305-29-40 _ _	VW6305-29-40 _ _	\$2,222	Oil-Rubbed Bronze	CLEAR
			V6306-11-40 ①-②③	VW6306-11-40 ①-②③	\$2,372	Bright Chrome	CLEAR
			V6306-25-40 _ _	VW6306-25-40 _ _	\$2,580	Brushed Nickel	CLEAR
			V6306-29-40 _ _	VW6306-29-40 _ _	\$2,766	Oil-Rubbed Bronze	CLEAR
			V6308-11-40 ①-②③	VW6308-11-40 ①-②③	\$2,871	Bright Chrome	CLEAR
			V6308-25-40 _ _	VW6308-25-40 _ _	\$3,090	Brushed Nickel	CLEAR
			V6308-29-40 _ _	VW6308-29-40 _ _	\$3,322	Oil-Rubbed Bronze	CLEAR

Shown with optional Towel Bar

*BASE	PRICE	COLOR	SIZE
ABF3672-18K	\$931	White	72" x 36" x 2 3/4"
ABF3672-13K	\$978	Biscuit	72" x 36" x 2 3/4"

ABF
Acrylic Base



CONTINUED ON NEXT PAGE

DRAIN	NO-CALK™ SHOWER BASE DRAIN*	DRAINABS-11	ABS No-Calk 2" drain	\$29	Chrome
		DRAINABS-25	ABS No-Calk 2" drain	\$39	Brushed Nickel
		DRAINPVC-11	PVC No-Calk 2" drain	\$29	Chrome
		DRAINPVC-25	PVC No-Calk 2" drain	\$39	Brushed Nickel

*Please check local codes to ensure appropriate drain specifications

- ADDITIONAL RETURN PANEL SIZES ARE AVAILABLE.
- CONTACT CUSTOMER SERVICE FOR DETAILS.

SELECT OPTIONS

*SEE BASE SECTION FOR ADDITIONAL COMPATIBLE SHOWER MODELS AND TECHNICAL SPECIFICATIONS

Insert Code L or R

①

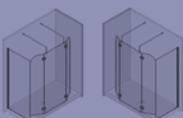

0414

"L"

"R"

Insert Code M, Q, T or R

②

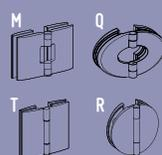

③

Insert Code H (flat) or Y (round) to select OPTIONAL TOWEL BAR

Towel Bar installs onto a panel

Available in two finishes:
CHROME - Surcharge \$225
BRUSHED - Surcharge \$209

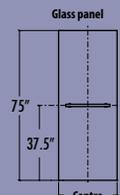

www.designashower.com

6' WALK-IN SHOWER SYSTEM



6' WALK-IN SHOWER SYSTEM (CONT'D)

3/8" (10 mm) Clear Tempered Glass • 75" H (82 3/16" to top of support bar)

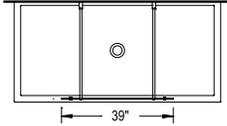
DIMENSIONS		MODEL	PRICE	FINISH	GLASS
 		V6309-11-40 ①-③	\$796	Bright Chrome	CLEAR
		V6309-25-40 _- _	\$866	Brushed Nickel	CLEAR
		V6309-29-40 _- _	\$935	Oil-Rubbed Bronze	CLEAR

*BASE	PRICE	COLOR	SIZE
ABF3672-18K	\$931	White	72" x 36" x 2 3/4"
ABF3672-13K	\$978	Biscuit	72" x 36" x 2 3/4"

ABF
Acrylic Base



Support bar dimensions

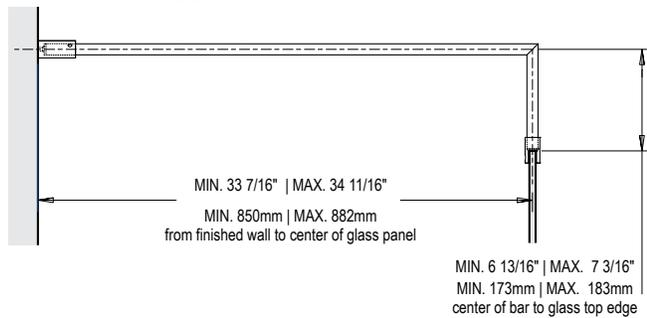

DRAIN NO-CALK™ SHOWER BASE DRAIN*	DRAINABS-11		ABS No-Calk 2" drain		\$29	Chrome
		DRAINABS-25		ABS No-Calk 2" drain		\$39
	DRAINPVC-11		PVC No-Calk 2" drain		\$29	Chrome
	DRAINPVC-25		PVC No-Calk 2" drain		\$39	Brushed Nickel

*Please check local codes to ensure appropriate drain specifications

SELECT OPTIONS

Insert Code H (flat) or Y (round) to select OPTIONAL TOWEL BAR

3

Towel Bar installs onto a front Panel

Available in two finishes:
CHROME - Surcharge \$225
BRUSHED - Surcharge \$209

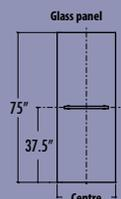

*SEE BASE SECTION FOR ADDITIONAL COMPATIBLE SHOWER MODELS AND TECHNICAL SPECIFICATIONS

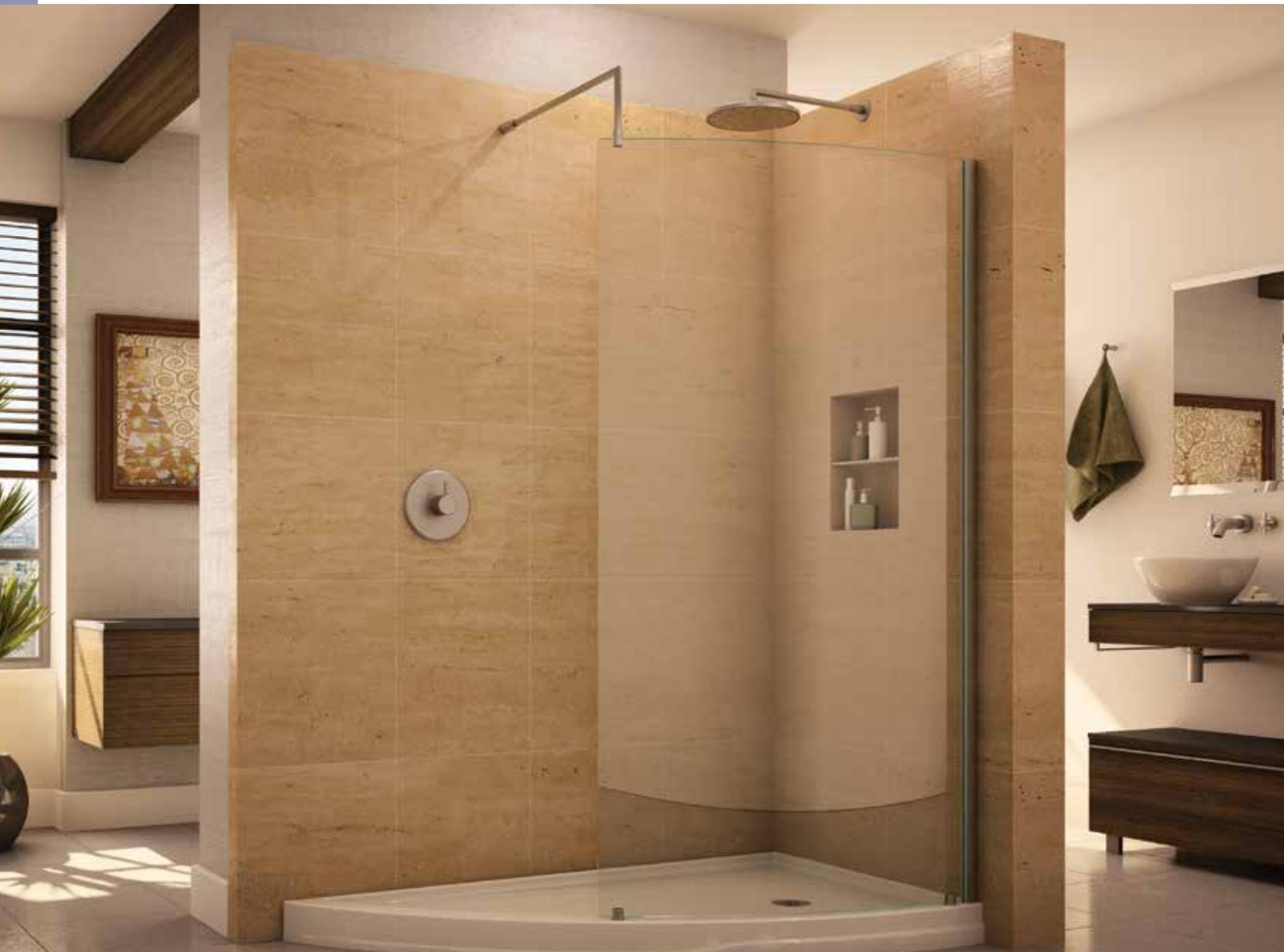

MODEL V6636-11-40R

 FLEURCO

www.designashower.com

79" H (86 13/16" to top of support bar) • Approximate opening - 22"

5/168" (8 mm) CLEAR TEMPERED GLASS

MODEL	PRICE	FINISH	GLASS
V6636-11-40 ①	\$1,144	Bright Chrome	CLEAR
V6636-25-40 _	\$1,225	Brushed Nickel	CLEAR
V6636-29-40 _	\$1,319	Oil-Rubbed Bronze	CLEAR

*BASE	PRICE	COLOR	DRAIN	SIZE
ABSL66-18LK	\$864	White	Left side	66" x 38" x 5"
ABSL66-18RK	\$864	White	Right side	66" x 38" x 5"

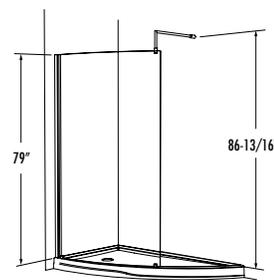

ABSL66-18LK

Left-side Acrylic Base



ABSL66-18RK

Right-side Acrylic Base

*SEE BASE SECTION FOR ADDITIONAL COMPATIBLE SHOWER MODELS.

Insert Code L or R

1

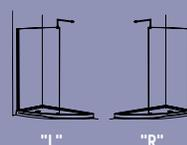

 **Microtek**
by Fleurco
Glass surface protection.
See information sheet at the end
of this section for ordering details.

Microtek Glass Protector



Protect your shower glass and extend its life by choosing Microtek, Fleurco's unique water repellent coating. Microtek uses the latest technology to offer easy maintenance and a hygienic environment. Microtek protects your glass for up to ten years.

COMPARED WITH ORDINARY GLASS, MICROTEK:

- Resists staining from hard water deposits.
- Is easier to clean.
- Does not support the growth of bacteria.
- Eliminates the need for harsh and abrasive cleaning products.

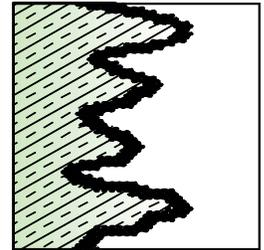

YOUR GLASS PROTECTED WITH MICROTEK

- Saves time and effort.
- Stays cleaner longer.
- Creates a more hygienic environment.



PRECAUTIONS

- Avoid using abrasive cleaners.
- Hydrofluoric and phosphoric acid can damage glass surface and should not be used.
- Do not use abrasive scouring powders or pads, highly acidic/alkaline cleaners, brushers, razor blades or other sharp objects which may scratch or harm the glass surface.

MAINTENANCE

A soft cloth is all you need to clean your protected glass. For best results, squeegee dry after each use.

ORDER INFORMATION

WHEN ORDERING A DOOR WITH MICROTEK:

- Must be on a separate P.O.
- P.O. must contain the Item Number.
- On a separate line it must be marked with Microtek code (CS-1) and Left or Right as per the information / product line below.
- \$ 160/ panel.

PLATINUM

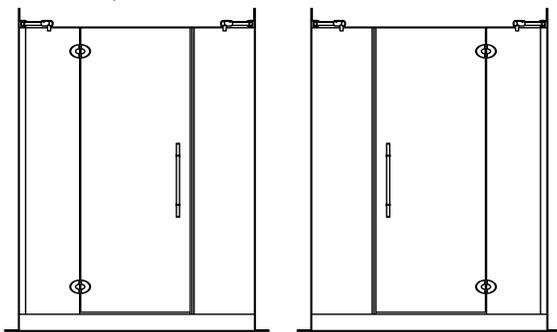

L

THE HINGES ARE INSTALLED ON LEFT SIDE OF DOOR AS VIEWED FROM THE EXTERIOR

R

THE HINGES ARE INSTALLED ON RIGHT SIDE OF DOOR AS VIEWED FROM THE EXTERIOR

EVOLUTION

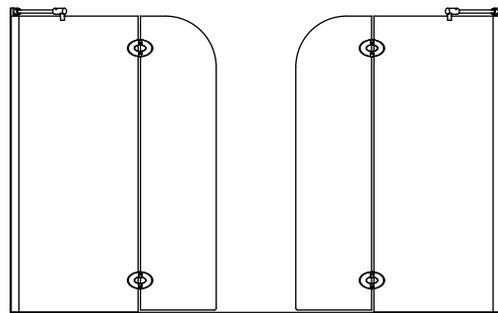

L

THE HINGES ARE INSTALLED ON LEFT SIDE OF PANEL AS VIEWED FROM THE EXTERIOR

R

THE HINGES ARE INSTALLED ON RIGHT SIDE OF PANEL AS VIEWED FROM THE EXTERIOR

EXAMPLE

LIST

Model # PXT57-11-40	\$ 1 933.00
CS-1 (3 PANELS / 1 SIDE) Specify L or R (see above)	\$ 480.00

EXAMPLE

LIST

Model # VXSH24-11-40	\$ 1 171.00
CS-1 (2 PANELS / 1 SIDE) Specify L or R (see above)	\$ 320.00

DURABILITY GUIDELINES

MICROTEK IS EXPECTED TO PERFORM FOR UP TO

10 YEARS

WARRANTY

Provided the glass is maintained according to published after-care instructions and without the use of abrasive cleaning methods or highly alkaline products, FLEURCO warrants that Microtek will work for up to ten (10) years from the date of application.